



How To Origami's Holiday Tree Ornaments



Contents

Fluted Diamond Ornament	3
Christmas Tree	6
Little Star	10
Cube Ornament	13
Christmas Star	16
Hanging Instructions	20

Fluted Diamond Ornament



Fluted Diamond Ornament

- ① Start with a normal origami square, pattern up

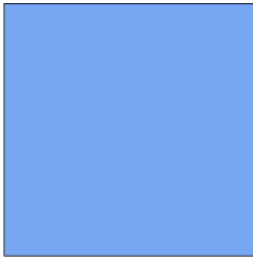

- ② Fold one diagonal, then unfold

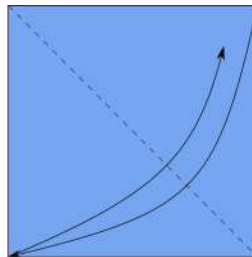

- ③ Fold other diagonal and unfold

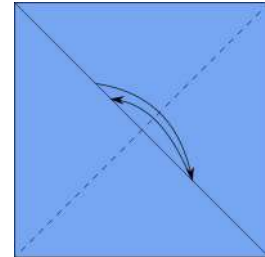

- ④ Flip over, and fold in half and unfold

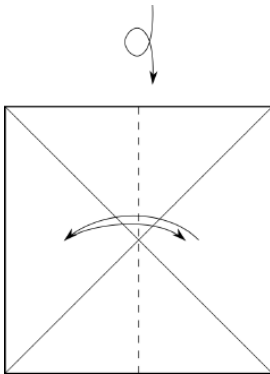

- ⑤ Fold in half the other way and unfold

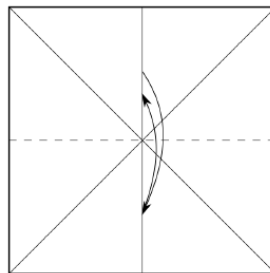

- ⑥ Press all other corners into the bottom right corner

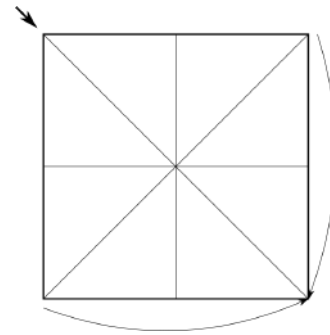

- ⑦ Continue to press corners inward as shown

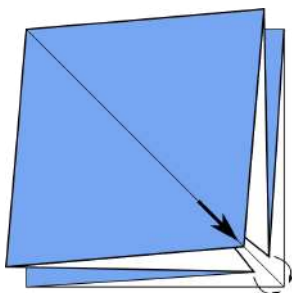

- ⑧ You should now have the Square Base

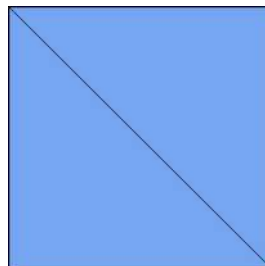

- ⑨ Rotate clockwise 45 degrees

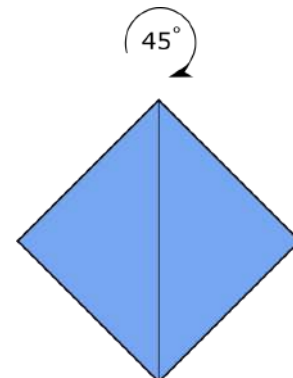

- ⑩ Lift top flap on right side up vertically

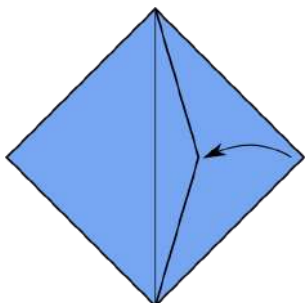

- ⑪ Press down on vertical flap so that it opens up as shown

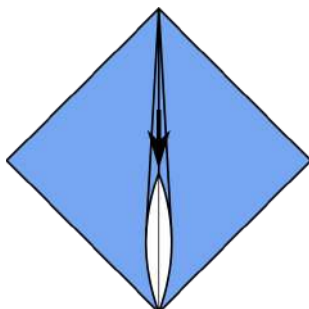

- ⑫ Continue pressing, then flatten out keeping center crease aligned

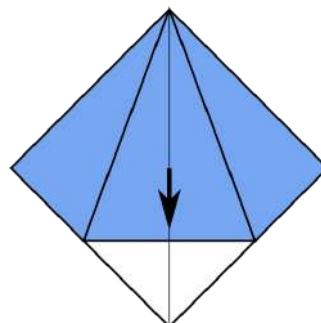

- ⑬ Fold both lower edges into the center crease

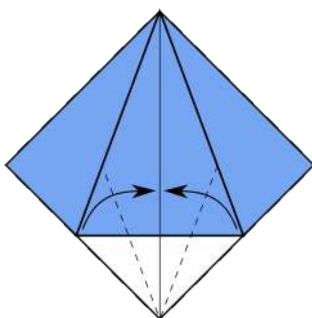

- ⑭ Model should look like this. Repeat steps 10—13 on three other flaps

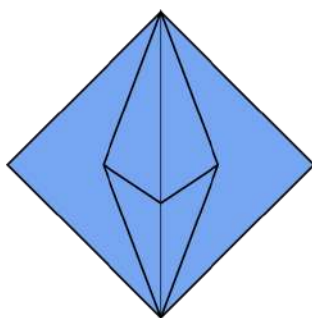

- ⑮ Complete model. Bend all flaps out to make 3D



- ⑯ Refer to hanging instructions to attach a paper clip hook. Awesome work!

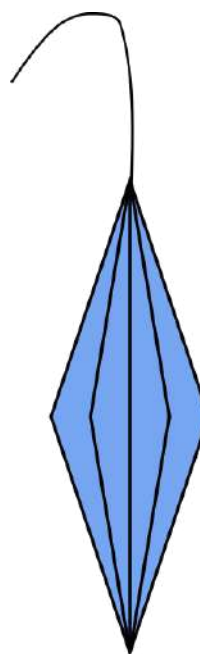

Christmas Tree Ornament



Christmas Tree Ornament

- ① Start with a normal origami square, pattern down

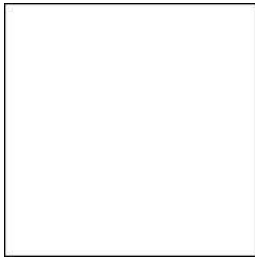

- ② Fold one diagonal, then unfold

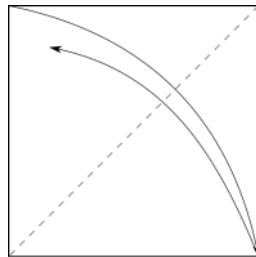

- ③ Fold other diagonal and unfold

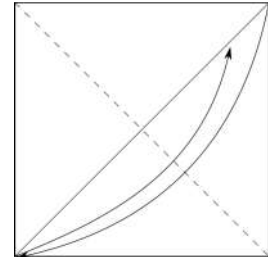

- ④ Rotate 45 degrees

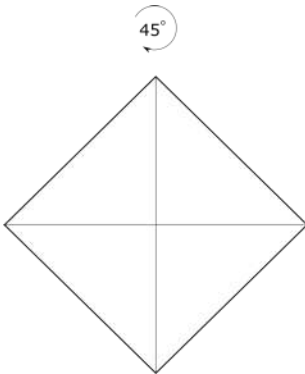

- ⑤ Fold two opposite corners to center, DO NOT crease

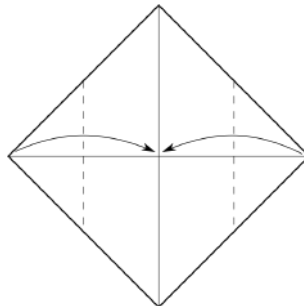

- ⑥ Press where the arrows indicate to "mark fold"

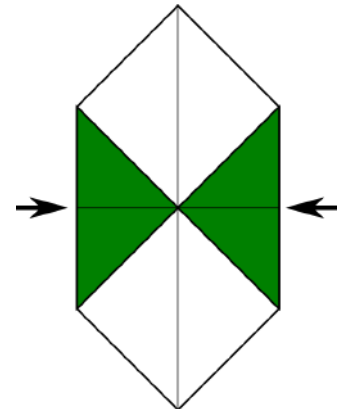

- ⑦ Unfold

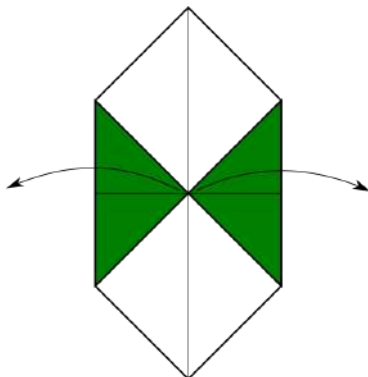

- ⑧ Fold same corners into mark. Again, mark fold

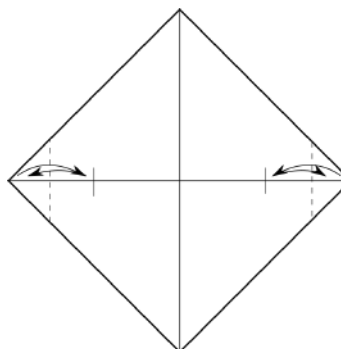

- ⑨ Fold right corner to far left mark fold, unfold

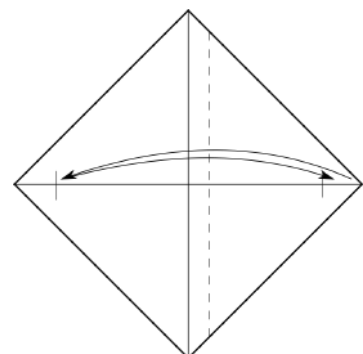

- ⑩ Fold left corner to far right mark fold, unfold

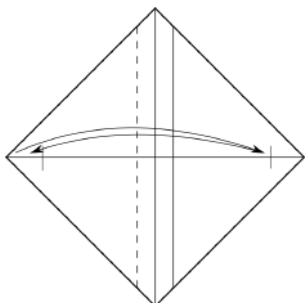

- ⑪ Fold upper left and right edges to center crease

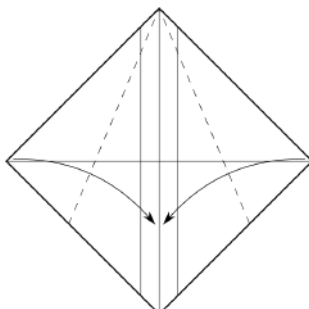

- ⑫ Mountain fold top point back to bottom point crease

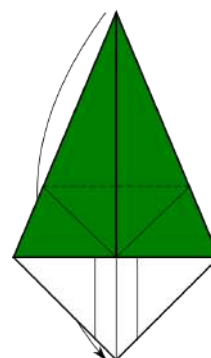

- ⑬ Fold bottom point up along line halfway through colored portion of paper

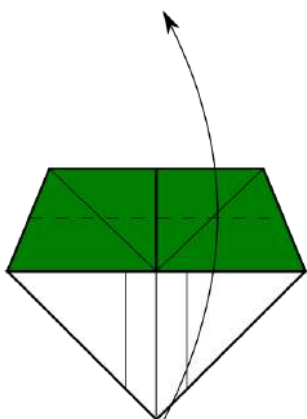

- ⑭ Model should look like this.

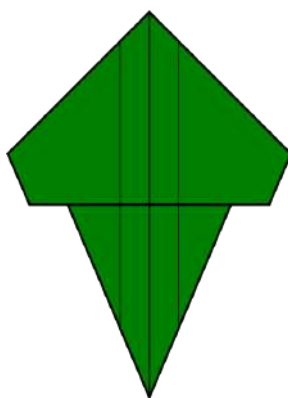

- ⑮ Fold as indicated, notice this step requires both mountain and valley folds

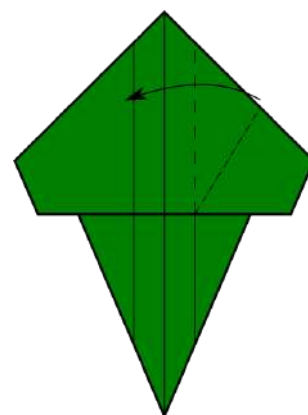

- ⑯ Refer to right side to ensure prior step was correct. Repeat on left.

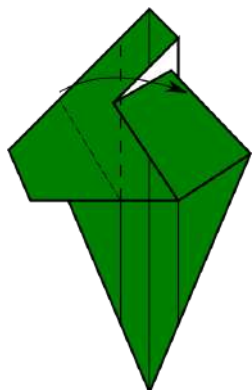

- ⑰ Fold top point down to complete the trunk.

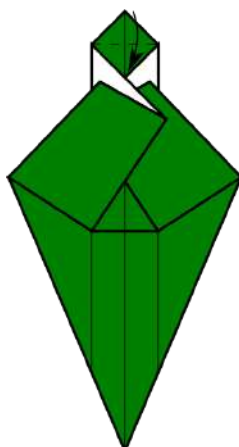

- ⑱ Flip over

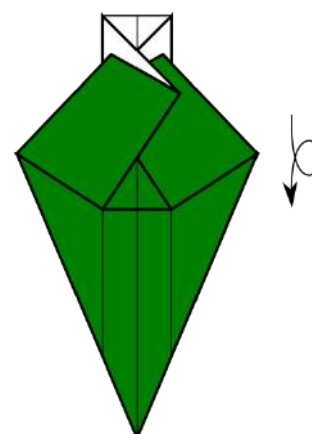

- ①⑨ Fold down on indicated line

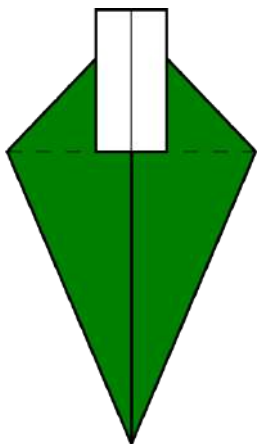

- ②⑩ Fold up so that all green is hidden when viewed from the other side

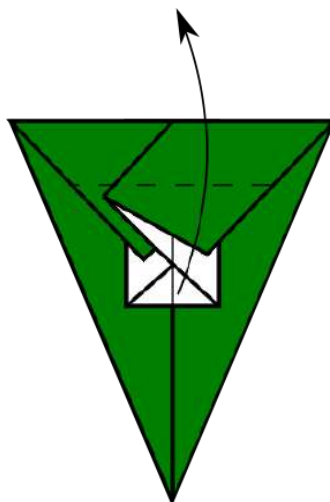

- ②⑪ Unfold crease made in step 19. There will be a pocket underneath. Tuck into pocket.

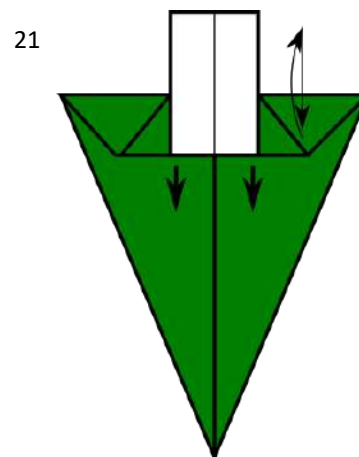

- ②⑫ Rotate 180 degrees

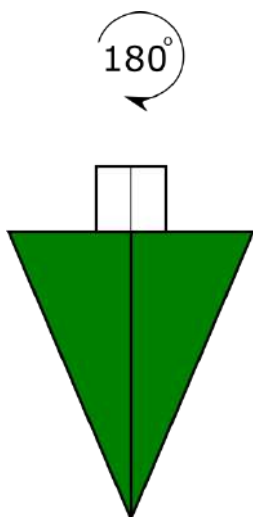

- ②⑬ Done! Attach hook.

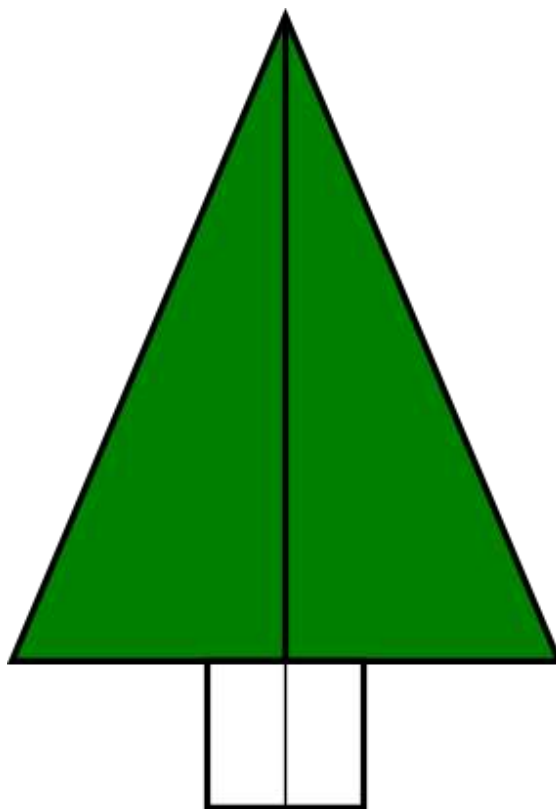

Little Star Ornament



Little Star Ornament

- ① Start with strip of paper with roughly a 1:15 ratio (2x28cm works)



- ② Loop one end behind to start knot

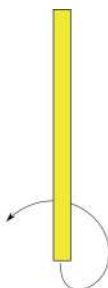

- ③ Loop should look like this

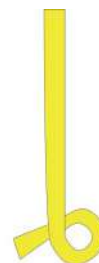

- ④ Take short end and feed it through hole

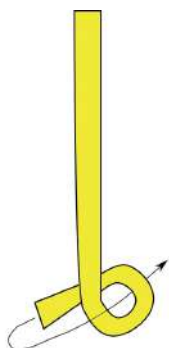

- ⑤ Knot should look like this. Pull and flatten.

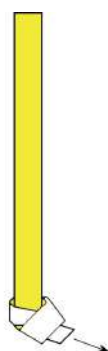

- ⑥ Final knot should form a pentagon

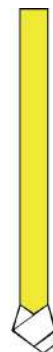

- ⑦ Mountain fold on one edge of the pentagon to begin wrapping the long end.

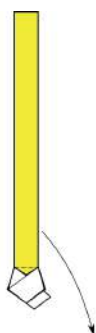

- ⑧ Valley fold back up along edge on pentagon.

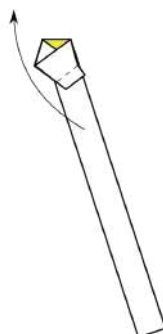

- ⑨ Continue wrapping pattern until only a small bit is left

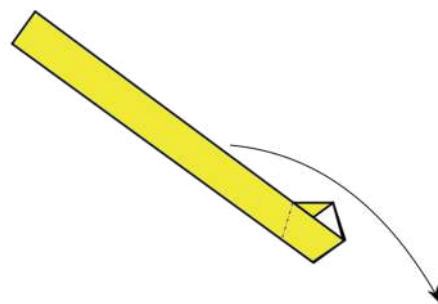

- ⑩ When finished, flip model to a side that looks like this. Tuck extra flap into pocket shown

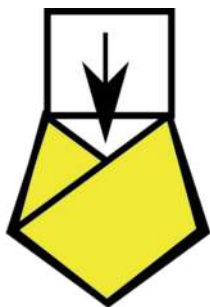

- ⑪ Once tucked, model should look like this

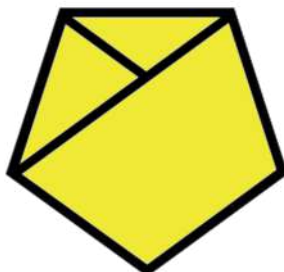

- ⑫ Pinch inwards slowly on sides. Star should inflate and become 3D

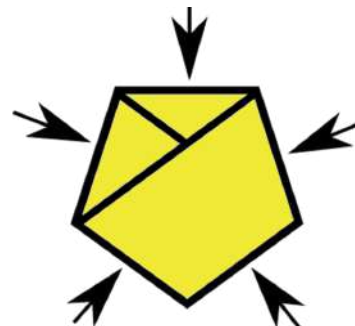

- ⑬ Done! Proceed to hanging Instructions.

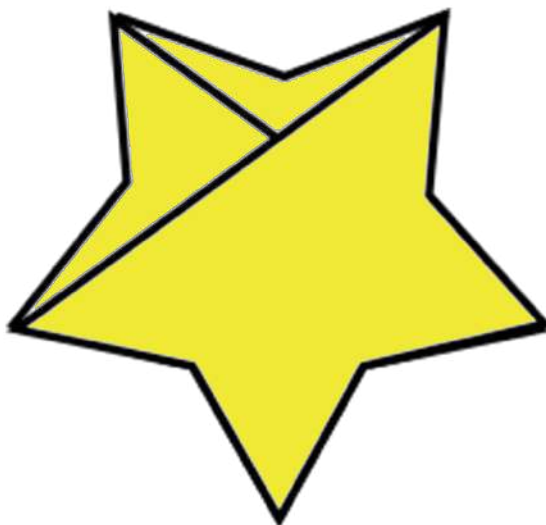

Cube Ornament



Cube Ornament

- ① Start with a normal origami square, pattern up

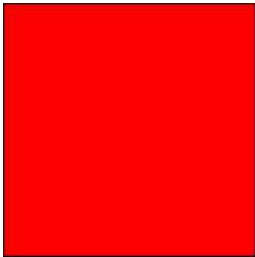

- ② Fold in half and unfold

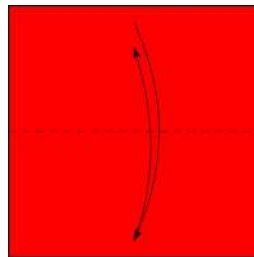

- ③ Fold in half the other way and unfold

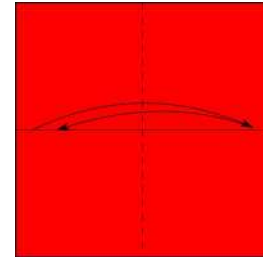

- ④ Flip over, and fold diagonally and unfold

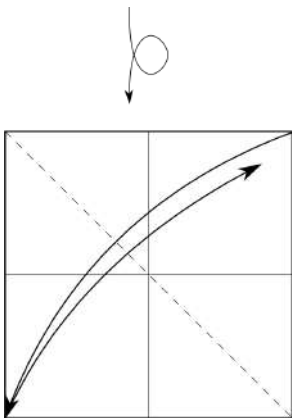

- ⑤ Fold in other diagonal and unfold

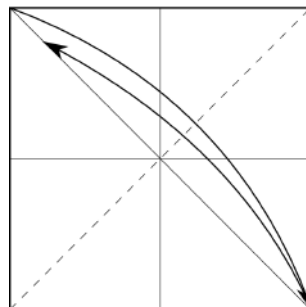

- ⑥ Press all edges to the bottom edge and valley fold on diagonals

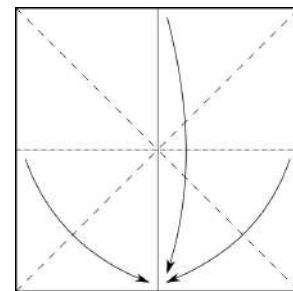

- ⑦ Press down on top edge

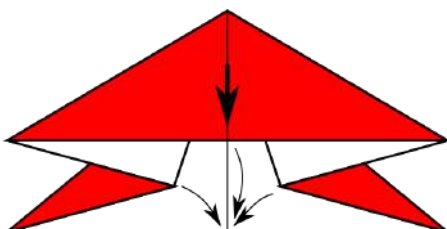

- ⑧ You should now have the Water Bomb Base

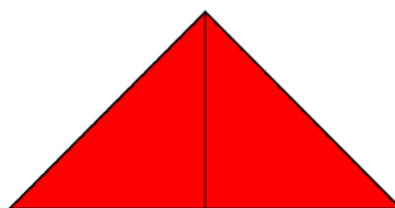

- ⑨ Fold left and right corners to the top point

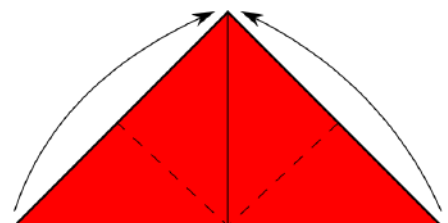

- ⑩ Fold corners into the center line

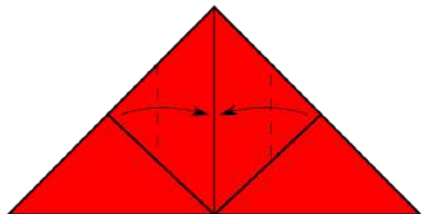

- ⑪ Corners should sit in the middle of the line

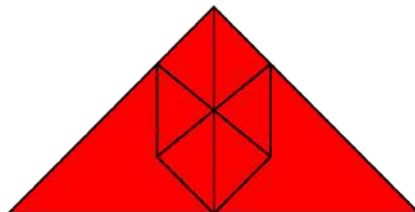

- ⑫ Fold both top flaps down and out

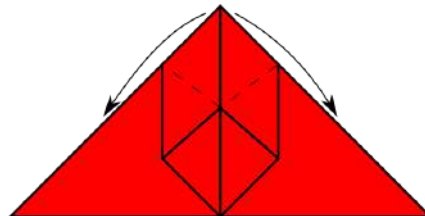

- ⑬ Fold both back in to create two triangular flaps

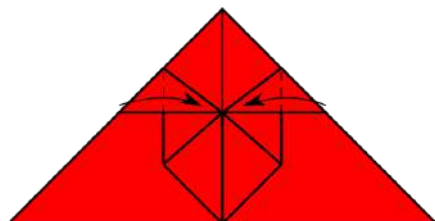

- ⑭ Undo fold in step 12

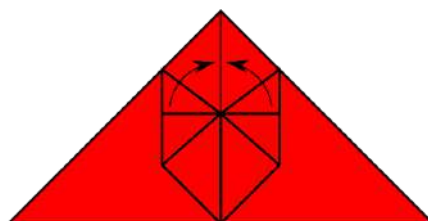

- ⑮ Two pockets should be present where arrows point. Tuck triangular flaps into pockets.

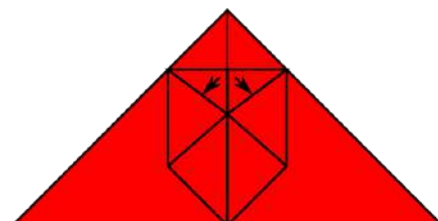

- ⑯ Flip over and repeat steps 9—15 on opposite side

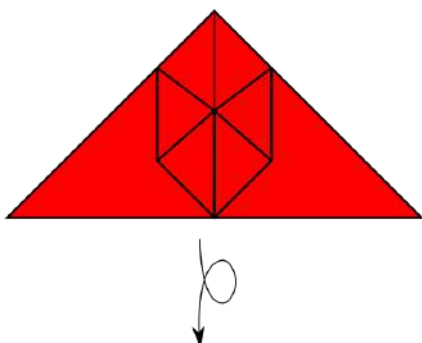

- ⑰ The bottom point of the model should have a hole. Blow into hole to inflate into cube.

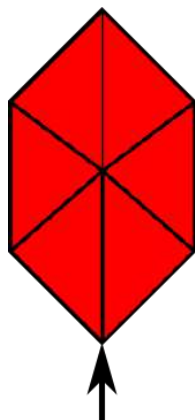

- ⑱ Finished! Now check out the hanging instructions!

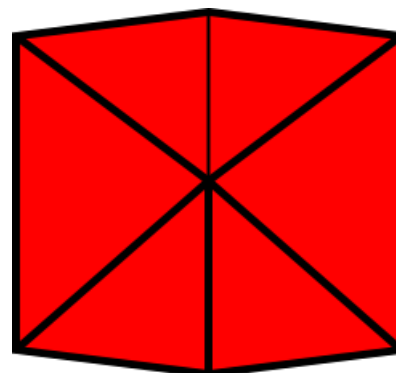

Christmas Star Ornament

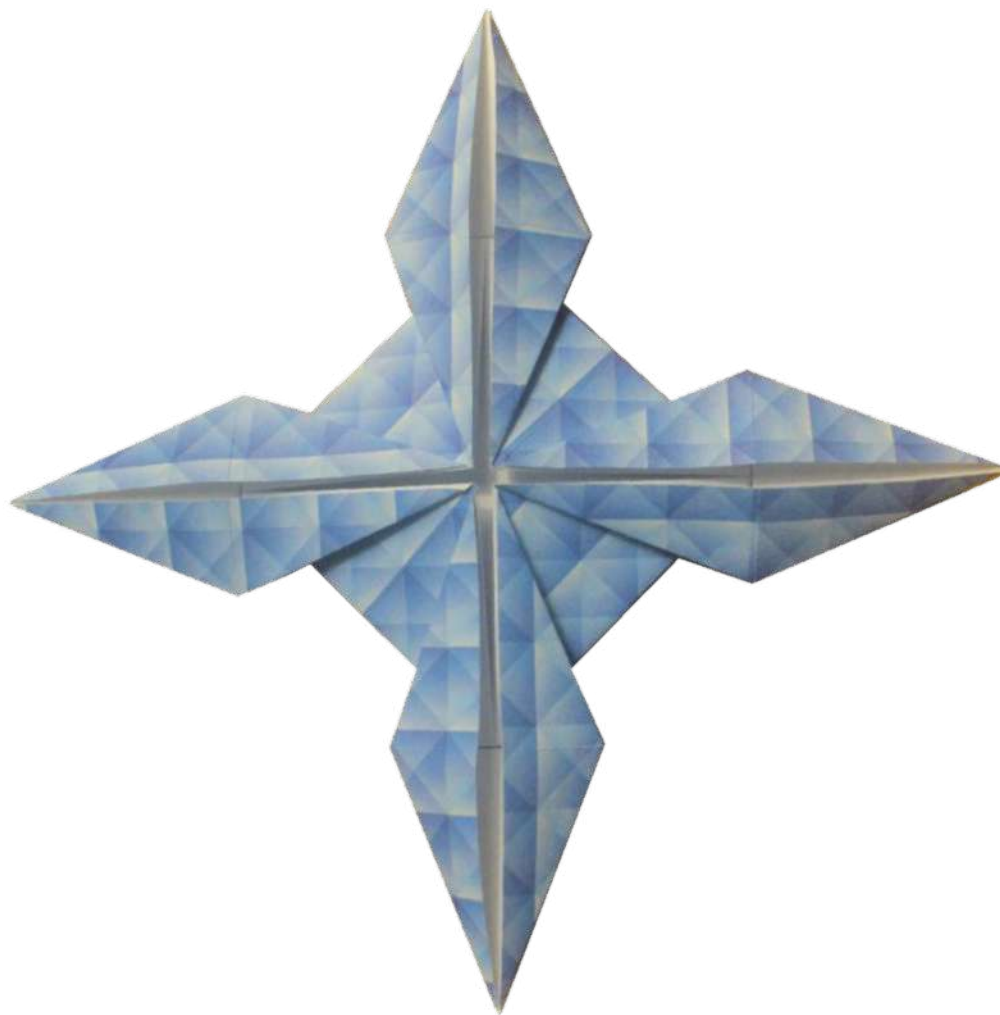

Christmas Star Ornament

- ① Start with a normal origami square, pattern down

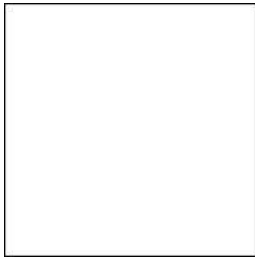

- ② Fold one diagonal, then unfold

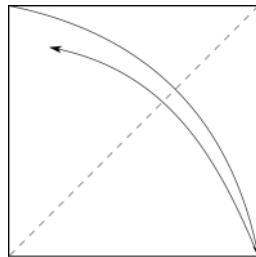

- ③ Fold other diagonal and unfold

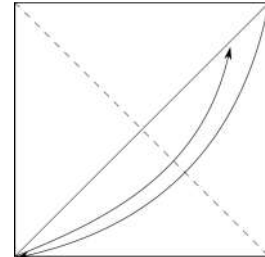

- ④ Flip over, and fold in half and unfold

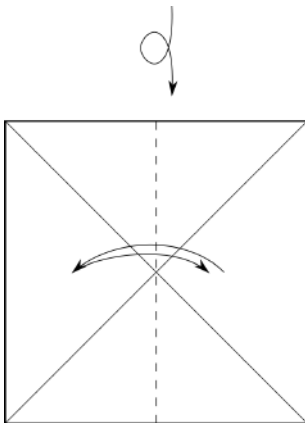

- ⑤ Fold in half the other way and unfold

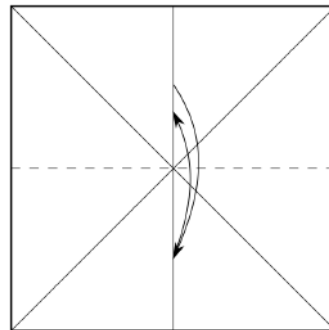

- ⑥ Fold top edge to be aligned with the center crease, then unfold

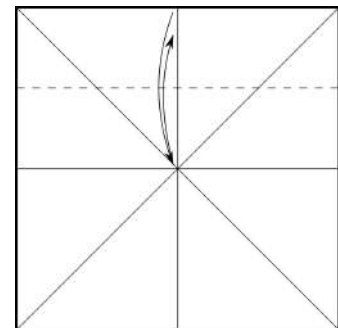

- ⑦ Fold all other edges to the center crease in the same way

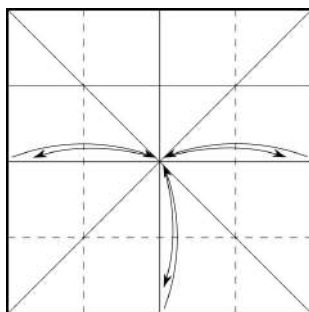

- ⑧ Fold top right corner into the center point then unfold

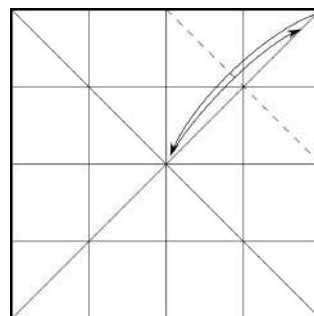

- ⑨ Do the same with other three corners

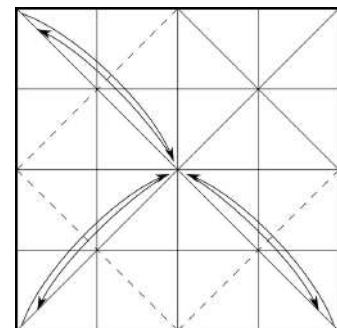

- ⑩ Finished fold pattern should look like this.

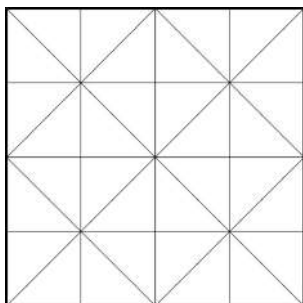

- ⑪ Fold all edges into the center at once, allowing corners to stick up

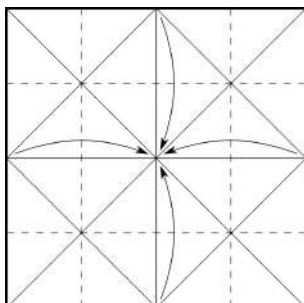

- ⑫ Model will look like this. Press down on corner flaps

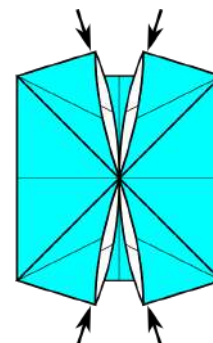

- ⑬ Keep pressing until they flatten out as shown.

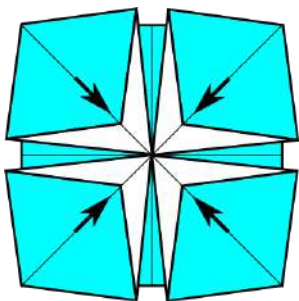

- ⑭ Model should look like this.

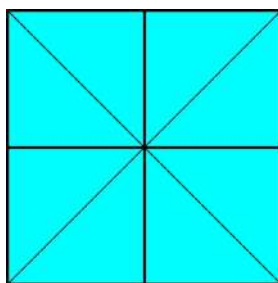

- ⑮ On upper right square, fold edges into diagonal and unfold

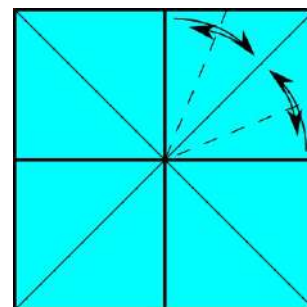

- ⑯ Fold upper right corner down as shown, then unfold

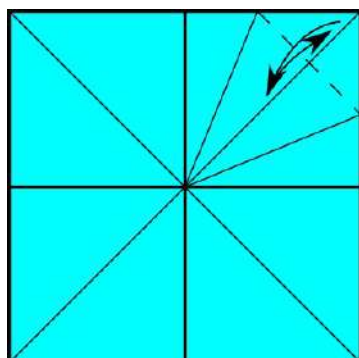

- ⑰ Petal fold the top layer by lifting up and allowing sides to collapse inwards

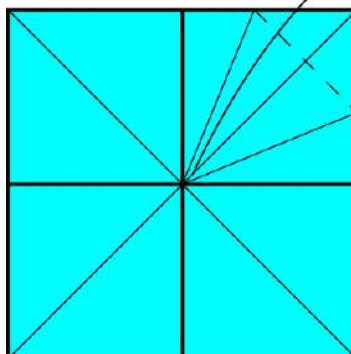

- ⑱ Result of petal fold should look like this.

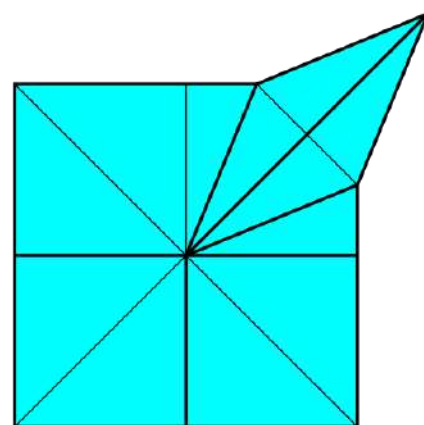

①9 Repeat steps 15 –18 on the 3 other squares

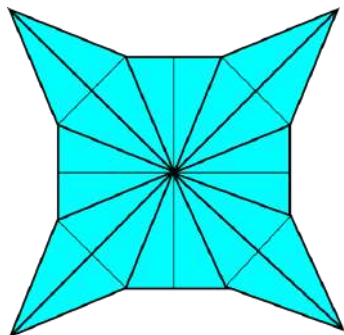

②0 Flip over

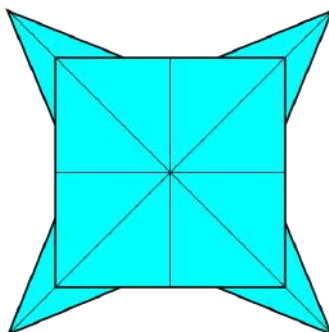

②1 Fold corners down as far as they can, then

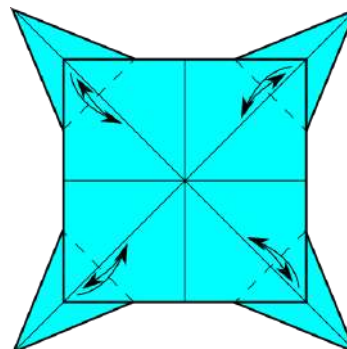

②2 Fold edges of square inwards where the previous crease crosses the diagonals

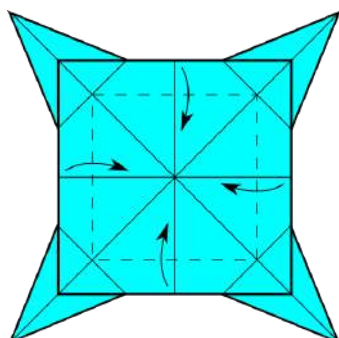

②3 Model should look like this. Press corners inwards and force fold them down

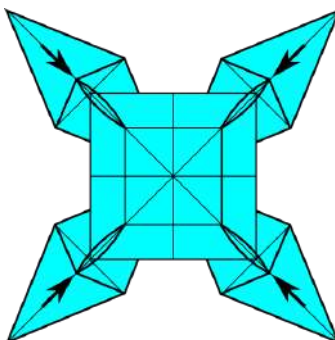

②4 Complete model should look like this. Flip over.

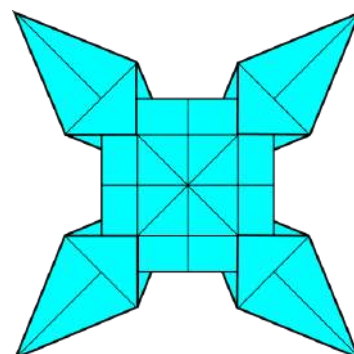

②5 Rotate 45 degrees and then attach a hook!

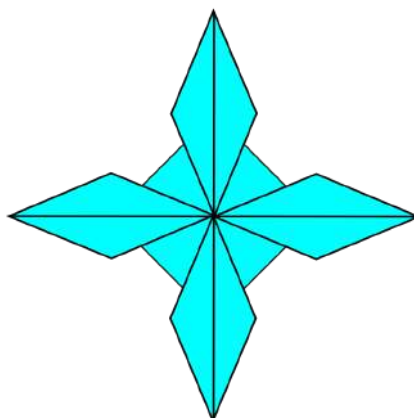

Hanging Instructions

- ① Take any sized paper clip and hold it in this orientation. Unbend the clip at the middle bend (bottom curve)



- ② Bend the smaller hook back to allow for easier taping

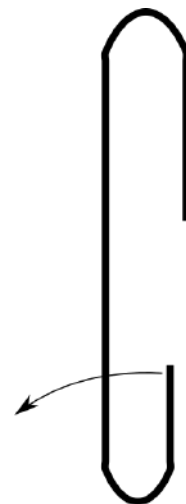

- ③ Unbend the larger hook slightly to allow for easier hanging



- ④ Tape bent smaller hook to the back of your ornament, and hang it up on your tree!



Happy Holidays to you and your family!

Subscribe to How To Origami on YouTube for more origami content!